

CX-CD282

HIGH POWERED WOOFER CD SYSTEM

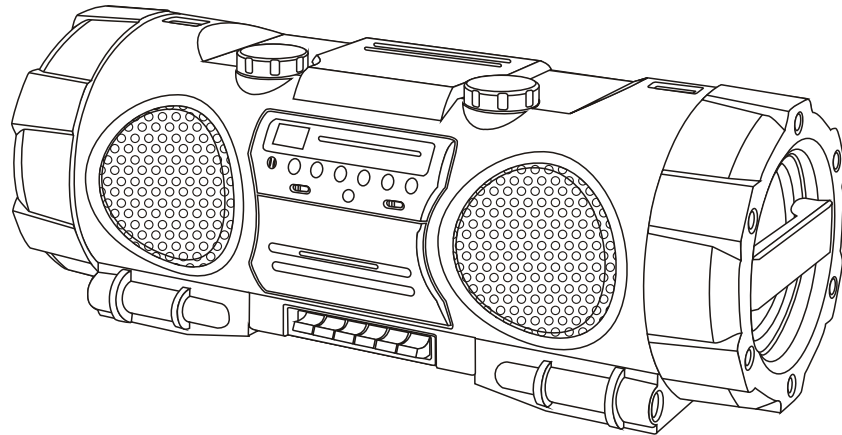

COBY®

OPERATING INSTRUCTION

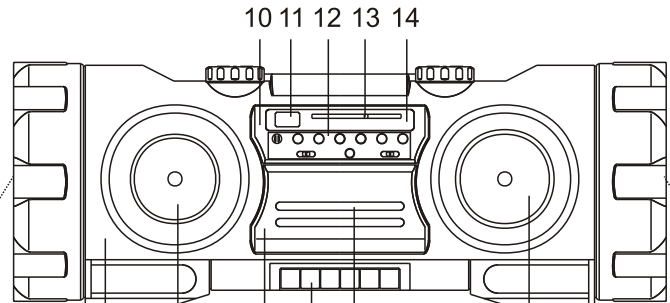
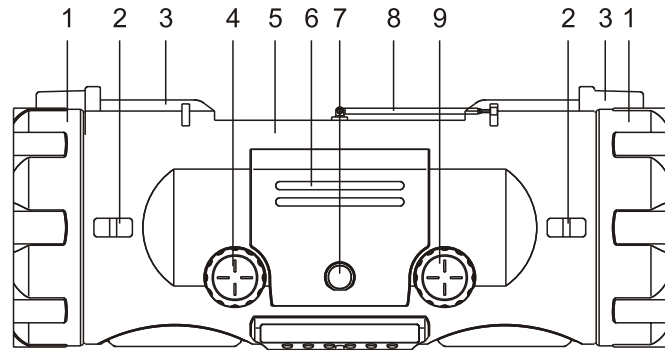

15 16 17 18 19 20 17 15

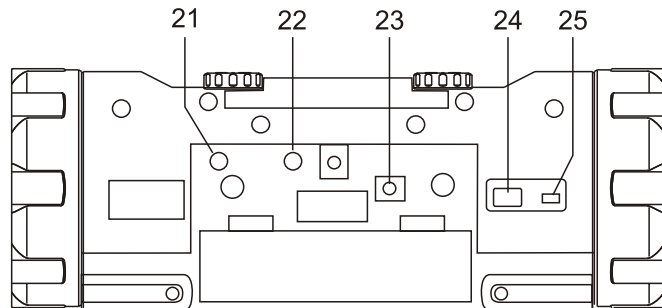

B CONTROLS

- 1 RIGHT/LEFT COVER
- 2 SHOULDER STRAP HOOK
- 3 BACK REVERBERANT TUBE
- 4 VOLUME CONTROL KNOB
- 5 BACK COVER
- 6 CD FRONT COVER
- 7 CD OPEN
- 8 ANTENNA
- 9 TUNING KNOB
- 10 FRONT CONTROL PANEL
- 11 LED
- 12 FUNCTION BUTTONS
- 13 INDEX/RULER INDEX/POINTER
- 14 POINTER LENS
- 15 RIGHT/LEFT SPEAKER
- 16 FRONT COVER
- 17 FRONT SPEAKER (RIGHT/LEFT)
- 18 CASSETTE COVER
- 19 CASSETTE CONTROL BUTTONS
- 20 CASSETTE COMPARTMENT
- 21 MICROPHONE JACK
- 22 PHONE JACK

- 23 DC JACK
- 24 AC IN
- 25 VOLTAGE SELECTOR

12 FUNCTION BUTTONS

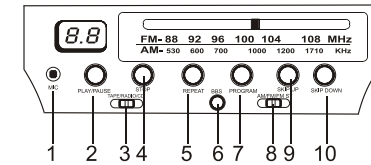

- 1 MIC
- 2 PLAY/PAUSE
- 3 FUNCTION SWITCH (TAPE/RADIO/CD)
- 4 STOP
- 5 REPEAT
- 6 BBS
- 7 PROGRAM
- 8 BAND SWITCH (AM/FM/FM ST)
- 9 SKIP UP
- 10 SKIP DOWN

C PRECAUTIONS

Read the Operating Instructions carefully and completely before operating the unit. Be sure to keep the Operating Instructions for future reference. All warnings and cautions in the Operating Instructions and on the unit should be strictly followed, as well as the safety suggestions below.

Installation

- 1 Water and moisture - Do not use this unit near water, such as near a bathtub, washbowl, kitchen sink, laundry tub, in a wet basement, swimming pool, or the like.
- 2 Heat - Do not use this unit near sources of heat, including heating vents, stoves, or other appliances that generate heat.
- 3 Mounting surface - Place the unit on a flat, even surface.
- 4 Ventilation - The unit should be situated with adequate space around it so that proper heat ventilation is assured. Allow 10 cm (4 in.) clearance from the rear and the top of the unit and 5 cm (2 in.) from each side.
 - Do not place the unit on a bed, rug, or similar surface that may block the ventilation openings.
 - Do not install the unit in a bookcase, cabinet, or airtight rack where ventilation may be impeded.
- 5 Objects and liquid entry - Take care that objects or liquids do not get inside the unit through the ventilation openings.
- 6 Condensation - Moisture may form on the CD Pickup lens when:
 - The unit is moved from a cold spot to a warm spot
 - the heating system has just been turned on
 - the unit is used in a very humid room

- the unit is cooled by an air conditioner
When this unit has condensation inside, it may not function normally. Should this occur, leave the unit for a few hours, then try to operate again.

Electric Power

Caution for Canadian users: To prevent electric shock, match wide blade of plug to wide slot, fully insert.

- 1 Power sources - Use on batteries or AC house current, as specified in the Operating Instructions and marked on the unit.
- 2 AC power cord
 - When disconnecting the AC power cord, pull it out by the AC power plug. Do not pull the cord itself.
 - Never handle the AC power plug with wet hands, as this could result in fire or shock.
 - Power cords should be firmly secured to avoid being bent, pinched, or walked upon. Pay particular attention to the cord from the unit to the power socket.
 - Avoid overloading AC power plugs and extension cords. beyond their capacity, as this could result in fire or shock.
- 3 When not in use - Unplug the AC power cord from the AC outlet or remove all the batteries if the unit will not be used for several months or more. When the cord is plugged in, a small amount of current continues to flow to the unit, even when the power is turned off.

D POWER SUPPLY



IMPORTANT

Make sure that function is set to TAPE before connecting the AC cord or inserting batteries.

CAUTION

Use only the supplied AC cord. Use with other cords may result in the risk of fire.
Before operating the unit for the first time or operating the unit in a new area, it is essential to assure that the setting of the VOLTAGE SELECTOR corresponds with the local voltage. To adjust the voltage, set the VOLTAGE SELECTOR to the local voltage with a screw driver.

Using on batteries

Open the lid of the battery compartment on the rear and insert ten (size D) batteries, not supplied, with the  and  marks correctly aligned. then close the lid.

To switch from AC power supply to battery power supply, disconnect the AC cord from the AC inlet.

CAUTION - to prevent electrical shock, match wide blade of plug to wide slot, fully insert.

The batteries need to be replaced when:
The tape speed slows down, volume decreases, or sound is distorted during operation.

notes on batteries

- Do not mix different types of batteries or old batteries with new ones.
 - Never recharge the batteries, apply heat to them or take them apart.
 - Remove dead batteries.
- If liquid leaks from the batteries, wipe thoroughly to remove.

E MAINTENANCE

To clean the cabinet

Use a soft cloth lightly moistened with mild detergent solution. Do not use strong solvents such as alcohol, benzine or thinner.

To clean the heads and tape paths



After every 10 hours of use, clean the Recording heads and Playback head, the pinch roller and capstan. Use a cotton swab 5 slightly moistened with cleaning fluid or denatured alcohol.

Cassette tapes



To prevent accidental erasure, break off the plastic tabs on the cassette tape after recording with a screwdriver or other pointed tool.





To record on the tape again, cover the tab openings with adhesive tape, etc.



F CD OPERATION

- 1 Set function switch to CD.
- 2 Push up PUSH OPEN to open the disc compartment and place a disc with the printed side up. The total number of tracks is displayed.
- 3 Press   PLAY/PAUSE to start play.
The number of the track being played is displayed.
- 4 Turn VOLUME and BBS to adjust the sound.

 STOP - Stops play.



  PLAY/PAUSE - Pauses play. To resume play, press again.

  SKIP/SEARCH - Searches for a particular point during playback. Keep  or  pressed and then release it.

- Skips to the beginning of a track. Press  or  repeatedly

REPEAT

Press REPEAT once - the indicator lights up and flash:

A single track is played repeatedly. Select a track with  or .

Press REPEAT twice- the indicator lights up:
All tracks are played repeatedly.

PROGRAM

In stop state, press PROGRAM and use skip/search to select the track. Will be program, press play to start program play.

NOTE

- Do not use irregular shape CDs(example: heart-shaped, octagonal ones). It may result in malfunctions.
- Do not place more than one disc in the disc compartment.
- Do not try to open the disc compartment during play.
- Do not touch the lens. Doing so may cause malfunctions.

G TUNER OPERATION

- 1 Set function to RADIO.
- 2 Select a band with BAND.
- 3 Tune to a station with TUNING.
- 4 Turn VOLUME and BBS to adjust the sound.

For better reception - Extend the FM antenna and orient it for the best reception; AM antenna is inside the unit.
Position the unit for the best reception.

FM /FM ST

Sets the FM sound to stereo or monaural.

FM ST: Reception is stereo.

FM: When an FM stereo broadcast contains noise, set to FM. Noise is reduced, although reception is monaural.

NOTE

If the unit picks up noise from other electrical appliances nearby, like a TV or fluorescent lights, move the unit away.

H MICROPHONE



1 Microphone plug diameter is 3.5mm.

2 Connect the microphone to "MICROPHONE" socket for MICROPHONE.

I TAPE OPERATION



Use Type 1 (normal) tapes only.

PLAYING BACK A TAPE

- 1 Set function switch to TAPE.
- 2 Press  STOP/EJECT to open the cassette holder and insert a tape with the exposed side down and the side to be played facing out.
- 3 Press  PLAY to start play.
- 4 Turn VOLUME and BBS to adjust the sound.



 STOP/EJECT - Stops play.

 PAUSE - Pauses play. To resume play, press again.

 F FWD/  REW - Fast forwards/rewinds. To stop winding, press  STOP/EJECT.

RECORDING

Note that recording is done on only one side of the tape.

- 1 Insert a tape with the side to be recorded facing out.
Wind up the tape to the point where recording starts.
- 2 Get ready to record from the source.
To record from a CD: set function to CD and start play.
To record from the tuner: set function to RADIO and tune to a station.
To record from built in MIC: set function to TAPE
- 3 Press  REC to start recording.
 PLAY is pressed simultaneously.

To stop recording, press  STOP/EJECT.

To erase a recording, set function to TAPE and start recording.

J GENERAL

To turn off the unit, set function switch to TAPE.

To listen with the headphones, connect headphones with a stereo mini plug to the PHONES jack.

If an erroneous display or malfunction occurs, disconnect the AC cord and remove all the batteries to turn off the display. Then turn the power back on.

COPYRIGHT

Please check the copyright laws relating to recordings from disc, radio or external tape for the country in which the machine is being used.

K SPECIFICATIONS

Tuner section

Frequency range, FM: 88~108MHz
AM: 530~1710KHz

Deck section

Track format- 4 track, 2 channels / Frequency range- Normal tape / Recording system ,AC bias /Erasing system-Magnet erase / Heads- Recording / playback head , Erasure head

CD player section

Disc- Compact disc / Scanning method - Non-contact optical scanner (semiconductor laser)

General

Speaker- 78 mm full-sound (2),120 mm woofer (2) / Output-Headphones jack (stereo ϕ 3.5mm), Microphone jack (mono ϕ 3.5mm) / Power output - 4W +4W / Power requirements- DC 15 V using ten size D batteries, DC jack in: DC 12~15V/1.5A, AC 110-127V/220-240V, 60Hz/50Hz / Weight - 5Kg (excluding batteries) / Dimensions - 560(W)x208(H)x226(D) mm
Accessory- AC cord (1).

• Specifications and external appearance are subject to change without notice.

WARNING:The power cord on this product contains lead, a chemical known to the State of California to cause [cancer, and] birth defects or other reproductive harm. **Wash hands after handling.**